

OLYMPUS[®]

ZUIKO DIGITAL
ED150mm f2.0

EN Instructions

For customers in Europe



The "CE" mark indicates that this product complies with the European requirements for safety, health, environment and customer protection. CE-mark products are for sale in Europe.

For customers in USA

FCC Notice

This device complies with part 15 of the FCC rules. Operation is subject to the following two conditions: (1) This device may not cause harmful interference, and (2) this device must accept any interference received, including interference that may cause undesired operation.

Any unauthorized changes or modifications to this equipment would void the user's authority to operate.

For customers in CANADA

This Class B digital apparatus complies with Canadian ICES-003.

Features

- The ED150mm f2.0 is a lens with high imaging capability, designed exclusively for use with Olympus FOUR THIRDS single-lens-reflex digital cameras.
- Dustproof and drip-proof construction.
- Super-telephoto lens corresponding to a 300 mm lens for a 35 mm camera.
- F2.0 high-quality lens with 11 elements in 9 groups including one Super ED and one ED glass elements (ED: Extra-low Dispersion).
- Can be used in combination with the optional EC-14 teleconverter. Set the aperture at composite f-stop of f4 or more.
- Can be used in combination with the optional EX-25 extension tube under the following conditions:

Focus adjustment	Working distance	Magnification (): When converted to 35 mm film camera
MF	79 cm – 126 cm (2.6 ft – 4.1 ft)	0.17X – 0.31X (0.34X – 0.62X)

This lens cannot be used in combination with the Olympus Macro Flash System.

Contents

• Features	10
• Nomenclature	11
• Lens Case (Provided)	11
• Attaching the Hood	12
• Storing the Hood	12
• Attaching and Detaching the Tripod Mount	12
• Focus Limit Switch	13
• Focus Stop Buttons	13
• Shooting Cautions	13
• Precautions: Be Sure to Read the Following	14
• Main Specifications	15

Nomenclature

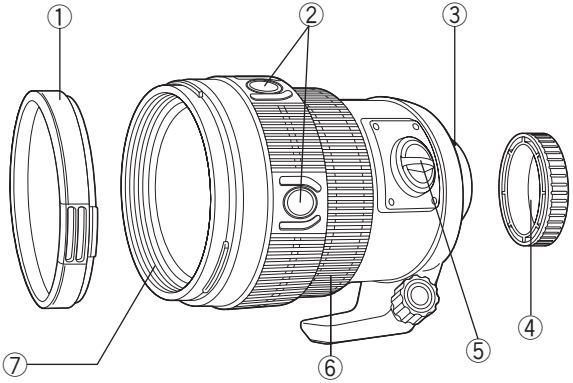

- ① Front cap
- ② Focus stop buttons (x4)
- ③ Mounting index
- ④ Rear cap
- ⑤ Focus limit switch
- ⑥ Focus ring
- ⑦ Filter mount thread

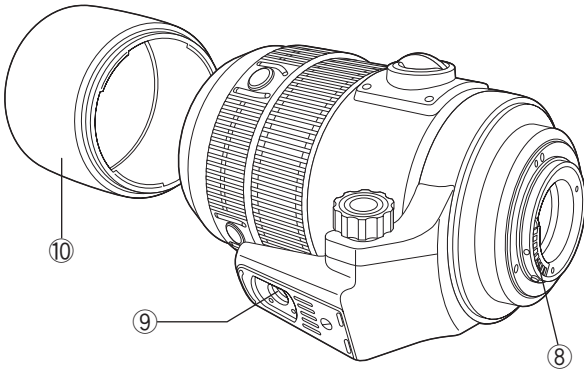

Lens Case (Provided)



• Attaching the lens case strap.

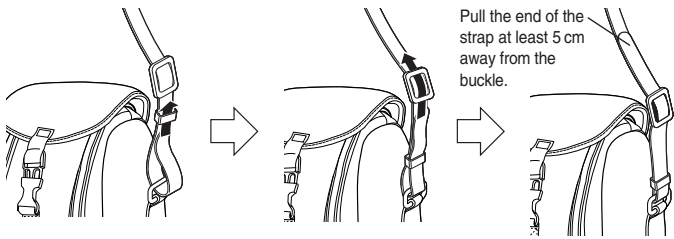

Pull the end of the strap at least 5 cm away from the buckle.

Attaching the Hood

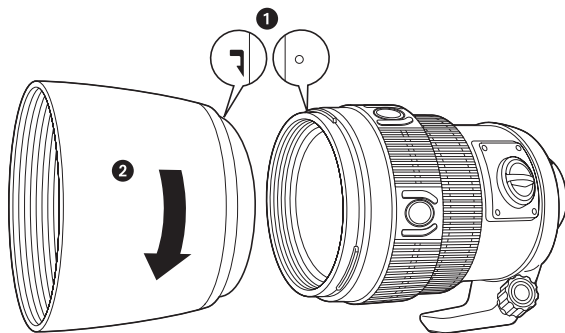

Storing the Hood

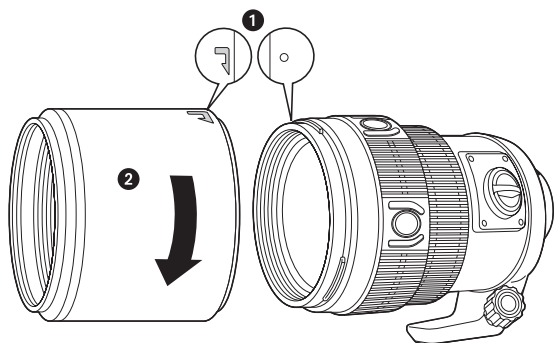

Attaching and Detaching the Tripod Mount

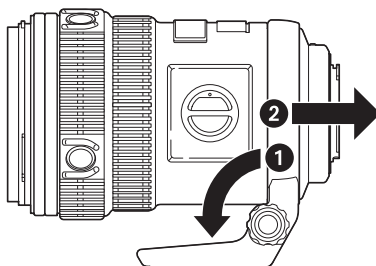

Focus Limit Switch

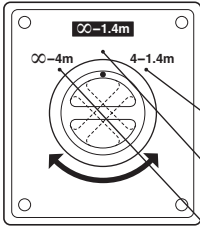

This switch limits the autofocus range to speed up focusing in each range.

Select the optimum mode according to the shooting distance.

- Close-up shooting : Autofocus is performed between 4 meters (13.1ft) and 1.4 meters (4.6 ft).
- Normal shooting : Autofocus is performed from ∞ (infinity) to 1.4 meters (4.6 ft).
- Distant shooting : Autofocus is performed from ∞ (infinity) to 4 meters (13.1 ft).

Focus Stop Buttons

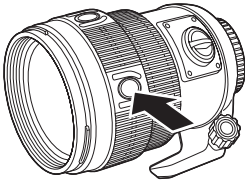

- By holding down one of the focus stop buttons, you can deactivate autofocus operation and fix focus at the point where the button was pressed.
- Four buttons are provided. All have the same effect.

Shooting Cautions

- Be sure to attach the hood when shooting against the light.
- When two or more filters are used or a thick filter is used, part of the picture may be cut off or obscured.

Precautions: Be Sure to Read the Following

⚠ Warnings: Safety Precautions



Do not view the sun through the lens.

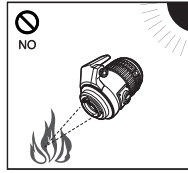

Do not leave the lens without the cap. If solar light is converged through the lens, a fire may result.

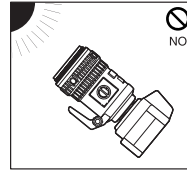

Do not point the camera lens at the sun. Sunlight will converge in the lens and focus inside the camera, possibly causing a malfunction or fire.

Handling Precautions

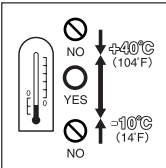

Working temperature range

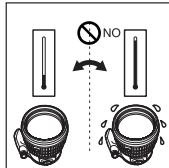

Abrupt temperature changes

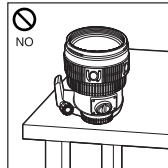

Do not put the lens with its contacts facing down.

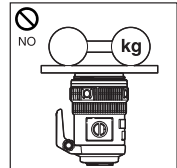

Too much pressure



Do not touch the lens.

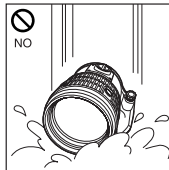

Submergence

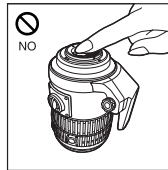

Do not touch the contacts.

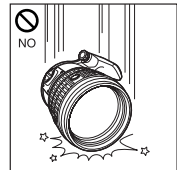

Do not drop

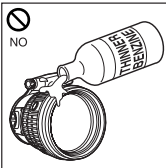

Organic solvents

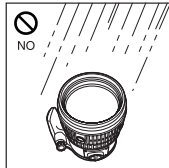

Excessive moisture

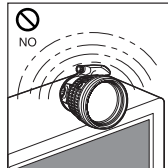

Magnetism

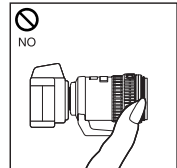

Do not hold the camera by the section of the lens extended by the focusing operation.

Storage Precautions

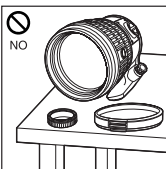

Cap the lens when it is not used.



Lens cleaning

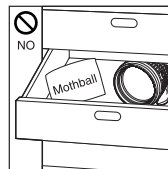

Moth repellents

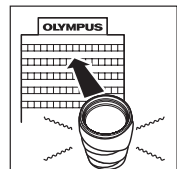

If you experience any problems, contact your nearest Olympus service center.

Main Specifications

Mount	: Four Thirds mount
Focal distance	: 150 mm
Max. aperture	: f2.0
Image angle	: 8.2°
Lens configuration	: 11 elements in 9 groups Multi-layer coating (partial single-layer coating)
Iris control	: f2.0 to f22
Shooting range	: 1.4 m (4.6 ft) to ∞ (infinity)
Focus adjustment	: AF/MF switching
Weight	: 1610 g (56.8 oz) (excluding hood and cap)
Dimensions	: Max. dia. ø100 mm (3.9 in) x Overall length 150 mm (5.9 in)
Lens hood mount	: Bayonet
Filter mount thread diameter	: 82 mm (3.2 in)

- Design and specifications are subject to change without any notice or obligation on the part of the manufacturer.

Lens configuration diagram

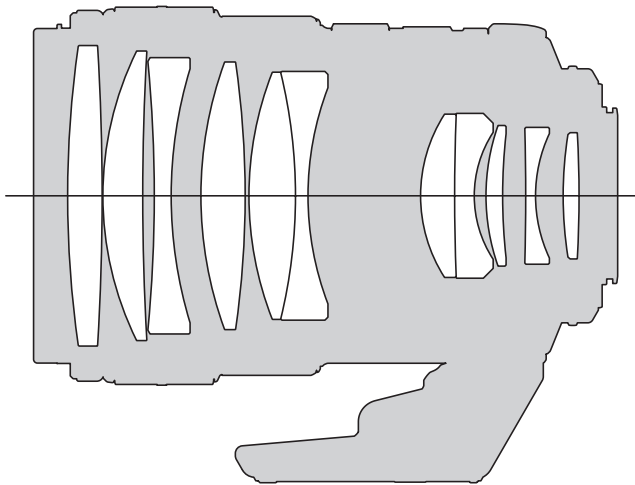

● Technical Support (USA)

24/7 online automated help: <http://www.olympusamerica.com/E1>

Phone customer : Tel.1-800-260-1625 (Toll-free)

Our phone customer support is available from 8 am to

10 pm (Monday to Friday) ET

E-Mail : e-slrpro@olympusamerica.com

● European technical Customer Support

Please visit our homepage <http://www.olympus-europa.com>

or call NUMBER : Tel.00800-67 10 83 00 (Toll-free)

+49 1805-67 10 83 or +49 40-23 77 38 99 (Charged)